

# **Power to Mars**

A technical report evaluating the use of ion harvesting technology for electrical power generation on Mars

Dr. A. Baumgaertner, Ph.D.

January 2016

# Table of Contents

1 Introduction.....	3
1.1 Climate on Mars.....	3
1.1.1 Predictability.....	4
1.1.2 Dust Storms.....	4
1.2 A Global Electric Circuit on Mars.....	6
1.2.1 Properties of the GEC on Mars.....	6
1.2.2 Technical usage of the GEC.....	6
2 Power generation technologies for Mars.....	9
2.1 Mars Ion Power technology.....	9
2.2 Solar Power.....	10
2.3 Nuclear Power.....	10
3 Options for power to Mars.....	11
3.1 Simulations for different locations and conditions.....	11
3.1.1 Case 1: An ion collector at 10m altitude on the plains.....	11
3.1.2 Case 2: balloon at 500m altitude.....	11
3.1.3 Case 3: Large ring structure on mountain/volcano.....	11
3.1.4 Case 2: Storm conditions.....	11
3.2 Comprehensive power generation concept.....	14
3.2.1 Phase 1: small station buildup.....	15
3.2.2 Phase 2.....	15
4 Summary.....	17
5 Appendix.....	17
5.1 GEC Model details and assumptions.....	17
5.2 Abbreviations and units.....	19
5.3 References.....	19

# 1 Introduction

NASA, other national space administrations around the world, foundations and other organizations have recently considered manned missions to Mars. For future human settlements on Mars, power generation will be one of the dominant questions that need to be addressed. This report considers “ion harvesting” as a power supply. Here, “ion harvesting” and “ion power” refer to using electricity from charge separation in dust storms or from the Mars Global Electric Circuit (GEC).

While still not directly observed, there are many indications that a GEC exists on Mars. It is driven by dust storms, which frequently occur on Mars. The dust storms are created by solar heating of the Martian surface. Therefore, the GEC is effectively driven by solar insolation similar to the GEC on Earth.

This report discusses the electrical properties of dust storms based on available literature, and presents new numerical simulations of the Mars atmosphere electrical properties. These allow conclusions to be drawn about the necessary system design specifications for “ion harvesting”, especially taking into account the importance of geographical location and altitude above the surface (e.g. using poles or balloons). **Overall, the results indicate that considering “ion power”, i.e. the fair-weather electric circuit or electricity inside of dust storms, has the potential to significantly contribute to power-production from other sources such as solar power.**

There are several key features of using “ion power” to the direct usage of solar energy through photovoltaic or solar thermal energy conversion:

1. No energy conversion is necessary, this is taken care of by the physical processes inherent in the GEC.
2. Power generation through the GEC occurring anywhere on the planet can be harvested in any other place on the planet. Day/night fluctuations of photovoltaic energy conversion do not occur

and no batteries are required. During the dust storm season harvesting is likely to work anywhere and anytime. For a station in the Northern Hemisphere of Mars, solar power will be available only intermittently during winter. Northern Hemisphere winter is also the dust storm season for the southern hemisphere, **thus making ion power a particularly well suited technology for complementing solar power.**

## 1.1 Climate on Mars

More than 100 years of observations of Mars have given us a good understanding of the changing patterns on that planet. Mars' axial tilt is 25.2°, similar to Earth's (23.4°). Therefore, Mars climate also exhibits seasons. The Martian year lasts 687 days, roughly 2 Earth years. The winters in the southern hemisphere are long and cold while those in the North are short and warm. The unequal season lengths are as follows:

Season	Sols (on Mars)	Days (on Earth)
Northern Spring, Southern Autumn:	193	93
Northern Summer, Southern Winter:	179	94
Northern Autumn, Southern Spring:	143	90
Northern Winter, Southern Summer:	154	89

Because the Mars Global Surveyor was able to observe Mars for 4 Martian years, it was found that Martian weather was similar from year to year. Any differences were directly related to changes in the solar energy that reached Mars. Scientists were even able to accurately predict dust storms that would occur during the landing of Beagle 2. Regional dust storms were discovered to be closely related to where dust was available.

The atmospheric surface pressure is 4-9 mb depending on season, much lower than on Earth (approximately 1000 mbar).

### 1.1.1 Predictability

“Weather forecasts” are much simpler on Mars than on Earth. This is based on the fact that less internal factors influence the atmosphere, there is no ocean, no biosphere, and no cryosphere. Instead, weather changes are most linked to changes in solar radiation alone. This means that dust storms can be accurately predicted. Therefore, it is likely that predictions of power generation from solar power and ion power, which both depend on solar radiation, weather and dust storms. A sophisticated numerical model setup would be required, based on a Mars General Circulation Model.

### 1.1.2 Dust Storms

On Mars a dust storm can develop in a matter of hours and envelope the entire planet within a few days. After developing, it can take weeks for a dust storm on Mars to completely expend itself. At this time, the exact distribution of dust storms over the planet as a function of Martian year is not fully known. However, there is indication that during dust storm season (northern fall and winter) at least one large regional storm may exist, along with numerous moderate-sized storms (Gierasch, 1974).

All Mars dust storms are powered by sunshine. Solar heating warms the Martian atmosphere and causes the air to move, lifting dust off the ground. The chance for storms is increased when there are great temperature variations like those seen at the equator during the Martian summer. Because the planet’s atmosphere is only about 1% as dense as Earth’s only the smallest dust grains hang in the air. Observations show that major dust storms typically originate in three general areas of Mars — Hellespontus, Noachis, and Solis Planum — all elevated plateaus that are between 20° and 40° S latitude. Major storms typically begin near or slightly before the time of southern hemisphere solstice, at the start of Martian southern hemisphere summer, or late spring; however, some years there are no major dust storms.

The major storms appear to go through three phases. In phase I, lasting about five days, the storms begin as bright spots or cores, about 400 km or smaller in diameter. Phase II is the expansion of the storm which can last from about 35 to 70 days. Expansion takes place by having secondary cores develop around the primary cores of the first phase, until eventually the entire planet is affected. Moreover, the development of the storm path does not seem to be topographically related; for the largest storms, the entire planet may be totally obscured. Phase III marks the decay of the storm and lasts from 50 to 100 days. The first areas to clear are the poles and topographically high regions, such as the summits of the shield volcanoes. Although major dust storms do not occur every year (phase II — expansion — may not fully develop), the occurrence is fairly frequent.

Average particle size in the atmosphere was found to be less than 2  $\mu\text{m}$ , or about the same as the particles carried over the Atlantic by major Saharan dust storms. The dust was found to be well mixed in the atmosphere to heights of 30 to 40 km and had the effect of raising the atmospheric temperature by as much as 50 K. For more information see e.g. Greeley et al. (1977). Laboratory experiments have been performed to further characterize Martian dust storms. Most notably the Martian Surface Wind Tunnel (MARSWIT) experiment at NASA-Ames has contributed to our current understanding, see Greeley et al. (1977).

Electrical properties of Martian dust storms have only been discussed in a few publications. Farrell and Desch (2001) derive vertical electric fields and currents for dust devils, small, moderate, as well as regional storm categories. Discharges inside the storms have been numerically simulated by Melnik and Parrot (1998), see Illustration 1 below. Note that because of the lower air pressure on Mars, the required voltage for electrical breakdown is lower than on Earth and could thus set a limit on generated currents.

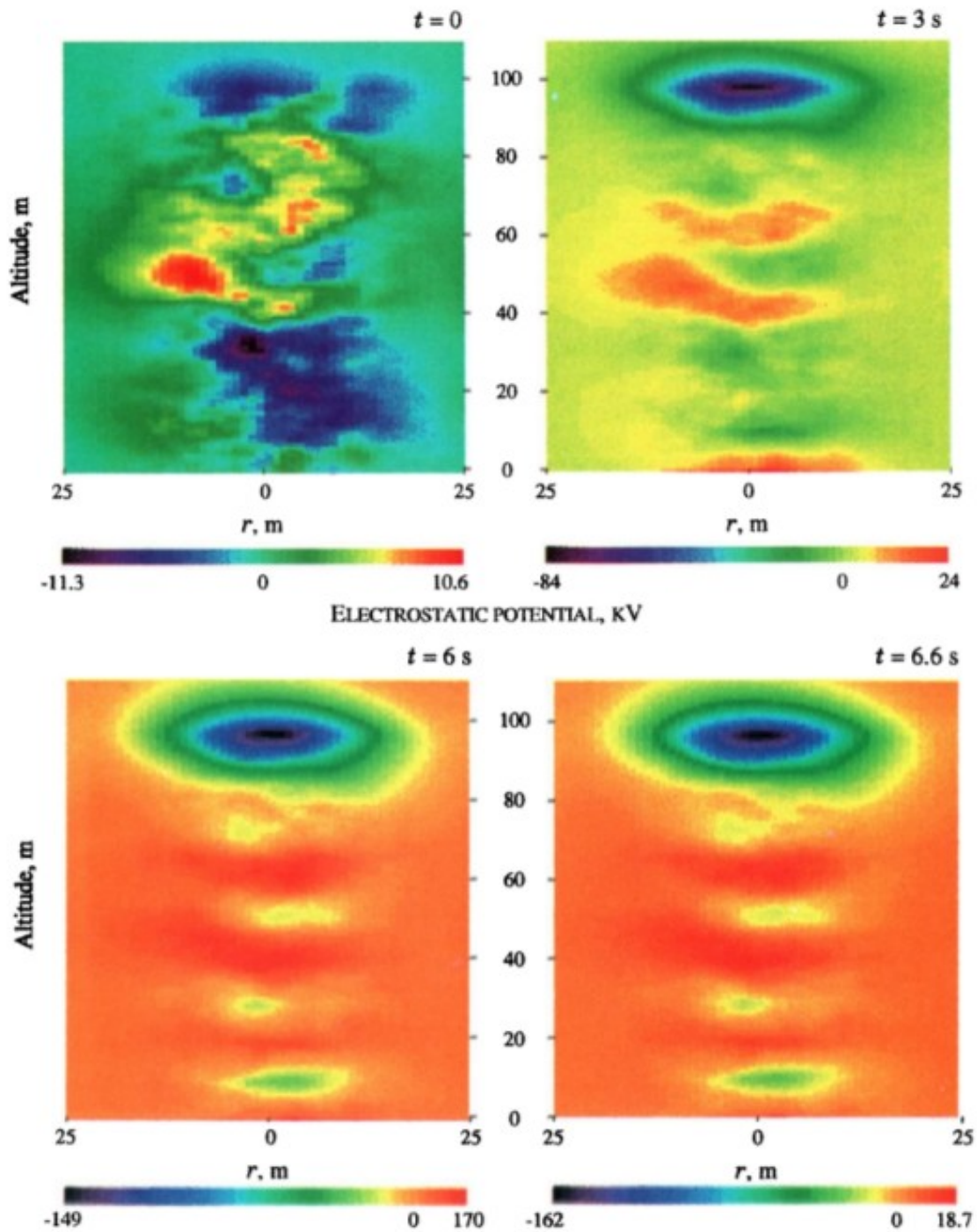

Illustration 1: Electrostatic potential at different times of the simulation by Melnik and Parrot (1998)

## 1.2 A Global Electric Circuit on Mars

From satellite and rover missions to Mars, as well as models, it seems very likely that an electric circuit (ion transport) exists on Mars. The strength, in other words its current flow, depends on season, in the active storm season during Martian southern summer it is much stronger than during the nonstorm season.

Just like on Earth, Galactic Cosmic Rays that originate outside of the solar system constantly ionize the atmosphere on Mars. This makes the atmosphere electrically conductive. However, without a power source no current flow through the atmosphere would occur.

On Earth, the current is generated by thunderstorms and electrified clouds. Through gravitational sorting, the heavier rimed hydrometers reside mostly in the lower portion of the cloud and the ice crystals are transported to the upper parts of the cloud, creating net negative and positive charge regions inside the cloud. Overall this leads to upward currents which charge the ionosphere with respect to the Earth's surface. This potential difference leads to a downward current everywhere else on the globe.

On Mars, electrical discharges originate from dust storms, that similarly to Earth can charge the Martian ionosphere. This will also lead to a downward current in Martian fair-weather conditions. Note however that the current direction is opposite to the GEC on Earth.

Most notably Farrell and Desch (2001) and Evtushenko (2015) have discussed possible existence of a Global Electric Circuit on Mars. Both conclude that at least for parts of the Martian year such a circuit does exist.

Also of importance for a fair-weather component of the GEC is the existence of an ionosphere. The main features and forcings associated with the dayside ionosphere on Mars

are depicted in Illustration 1. The Martian ionosphere has a stratified structure, with two main layers. The highest electron densities are found at an altitude of about 140 km, (indicated by M2) where extreme ultraviolet light from the Sun ionises the neutral atmosphere. Electron densities above this layer generally decrease with increasing altitude. A secondary layer (labeled as M1), which occurs at approximately 120 km, is produced by 'soft' X-rays from the Sun and associated impacts with energetic electrons. The meteoric ion layer is attributed to meteoroid ablation.

### 1.2.1 Properties of the GEC on Mars

Based on the assumptions and calculations by Farrell and Desch (2001) we derive some basic properties of the Martian GEC. Atmospheric conductivity can be calculated based on the rate of ionization from galactic cosmic rays (and possibly radioactive materials on the surface of Mars), and the ion-loss rate. Because of the pressure decrease with altitude, ion-loss rate decreases, leading to an increase of conductivity with altitude. Solving the relevant equations (see Appendix 5.1), the total resistance of Mars can be calculated. It amounts to approximately 12 Ohm. Given the dust storm electrical characteristics presented by Farrell and Desch (2001), an average current density of  $1.3 \text{ nA/m}^2$  can be derived. The average ionospheric potential amounts to 2300 kV.

For individual storms, Farrell and Desch (2001) list currents from only  $\mu\text{A}$  for dust devils up to the order of a MAmpere for regional and planet-encircling storms. For details see Table 2 in the next chapter.

Illustration 3 depicts the basic idea of the GEC on Mars. Based on the derived characteristics, a strong GEC is likely to exist on Mars at least during summer in the southern hemisphere.

## 1.2.2 Technical usage of the GEC

The GEC can be described as a current source (vs. a voltage source like a battery). An ideal current source could supply unlimited power, but it is limited by the atmosphere also being a load in

any circuit that uses the GEC. Technically this limits the usable circuit loads to resistances smaller than the atmospheric resistance and a technique for converting the high voltage electricity to low voltage electricity will be required.

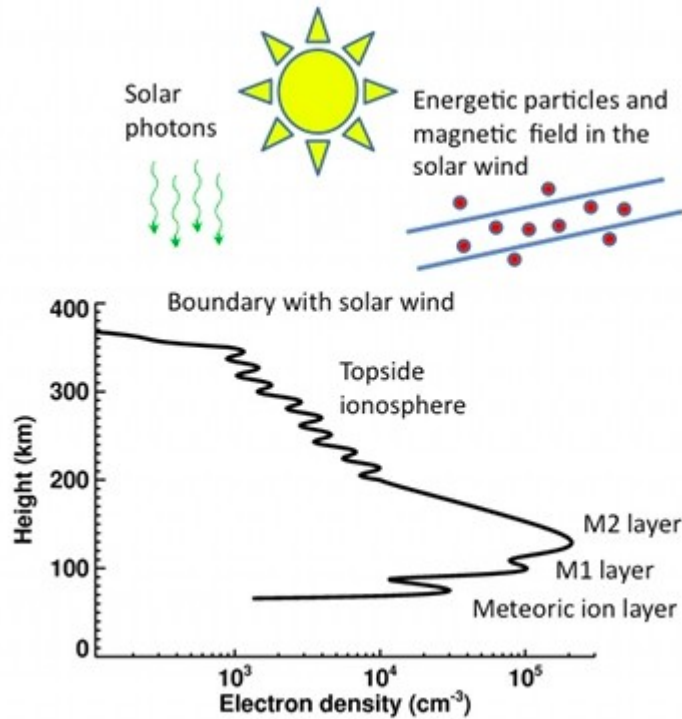
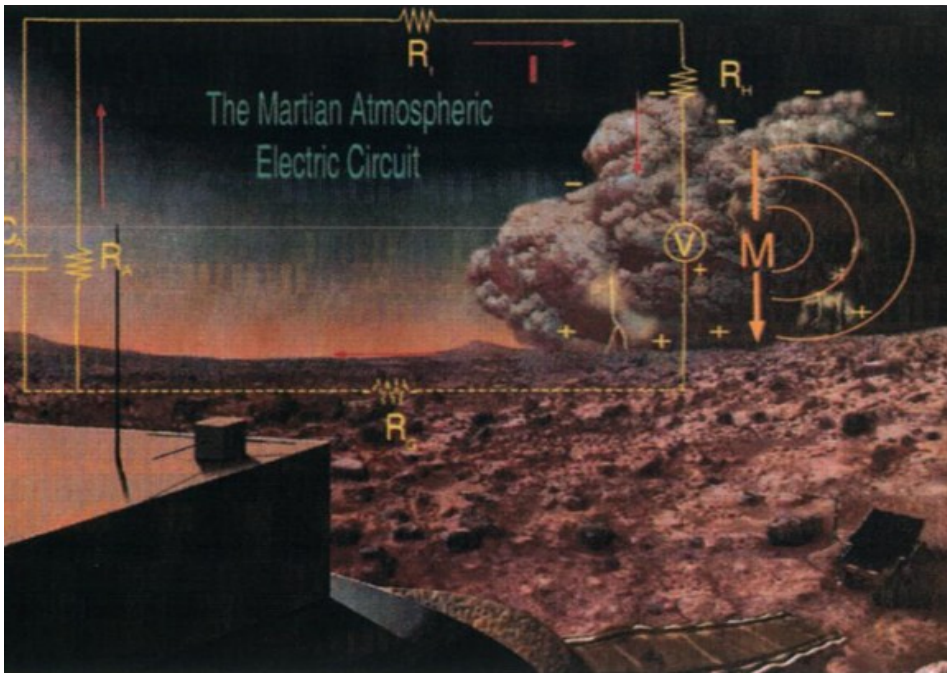

Illustration 2: Dayside ionosphere of Mars. Image courtesy of <http://sci.esa.int/mars-express/51107-dayside-ionosphere-of-mars/> / P. Withers, Boston University

Quantify		Reference
current density	1.3 nA/m <sup>2</sup>	Farrell and Desch (2001)
total current:	187 kA	Integrated current density
Total fair weather power during dust season:	400 GW (factor 4000-8000x compared to Earth)	$P = R \times I^2 = 4e11 \text{ W}$
potential	2.3 MV	from model, and $U=R \cdot I$

Table 1: Basic characteristics of the fair-weather global electric circuit on Mars

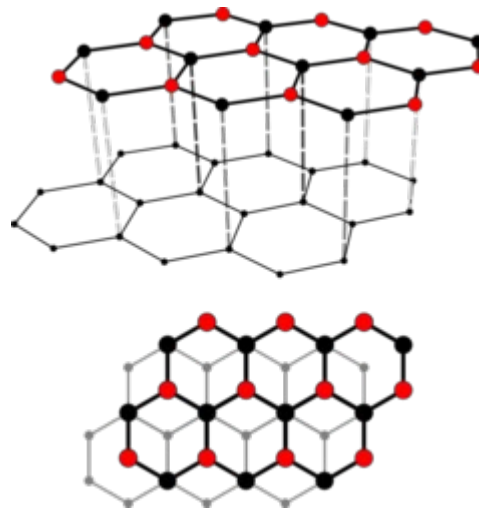

*Illustration 3: The Martian atmospheric electric circuit driven by triboelectrically active dust storms. Wind-blown dust creates an electric dipole moment pointed toward the ground, inducing downward current flow from the ionosphere to low altitudes. This current flow is ultimately drawn from the fairweather region which is required to "feed" the ionosphere and close the circuit. From Farrell and Desch, 2001.*

## 2 Power generation technologies for Mars

### 2.1 Mars Ion Power technology

Ion Power Group have internationally patented a technology to “harvest” electricity from the global electric circuit. They have shown that carbon graphite works well as an “ion collector”, i.e. to make use of the electrical power present in the GEC. Carbon graphite is a chemical form of carbon, i.e. an allotrope of carbon. For the atomic structure see Illustration 4. The fact that this material is well suited to work as an “ion collector” is based on its high electrical conductivity of  $1.00 \times 10^8$  S/m, which is 50% more than copper. In addition, it has a density of only 2.09–2.23 g/cm<sup>3</sup>, whereas copper is 4.5 times heavier. This makes it well suited for the proposed applications. The usage of ion power as a power source is shown in Illustration 5.



*Illustration 4: Carbon graphite atomic structure. Credit: graphic by deepkling, distributed under a CC BY-SA 3.0 license.*

There are two conversion methods for stepping down the high voltage electricity from the ion collectors to low voltage electricity necessary to



power devices and equipment. One conversion method uses electronic circuitry involving switches, DC/AC converters, voltage stabilizers and transformers. The other conversion method utilizes special high voltage motor designs to turn standard low voltage generator, dynamo, or alternator in order to step down the high voltage electricity to low voltage electricity. Ion Power Group is researching and developing both techniques.

Power output varies drastically depending on the location with respect to altitude, but also with time of year. Using numerical computer simulations, the amount of power-production is predicted for different conditions and scenarios in chapter 3.

Weight: One ion-collector weighs approximately 1g and is approximately 30cm long.

Durability: Ion-collectors are currently made of carbon fiber strips. These are e.g. used in the construction of police and army body armor such

as Kevlar, tank armor, airplane and racing car bodies, and many lightweight products requiring durability. The Ion Power Group has continuously used ion-collectors in Florida for over two years in weather conditions that occasionally reach other extremes (tropical storms, hurricanes, high winds, driving rain, intense UV). There, the carbon fiber ion-collectors have shown very good resiliency to harsh weather. The main factors for stress on materials on Mars will likely be the the temperature fluctuations as well as the solar radiation in the UV to X-ray. These conditions will shorten the life expectancy of any material on Mars, but to the current knowledge will not drastically reduce usability and durability of carbon graphite material for Mars settlements in the time frame of 2 to 10 years.

The amount of further resources needed is small. Compared to solar cells, which will entirely need to be transported from Earth, many components for ion power can be manufactured on Mars eventually.

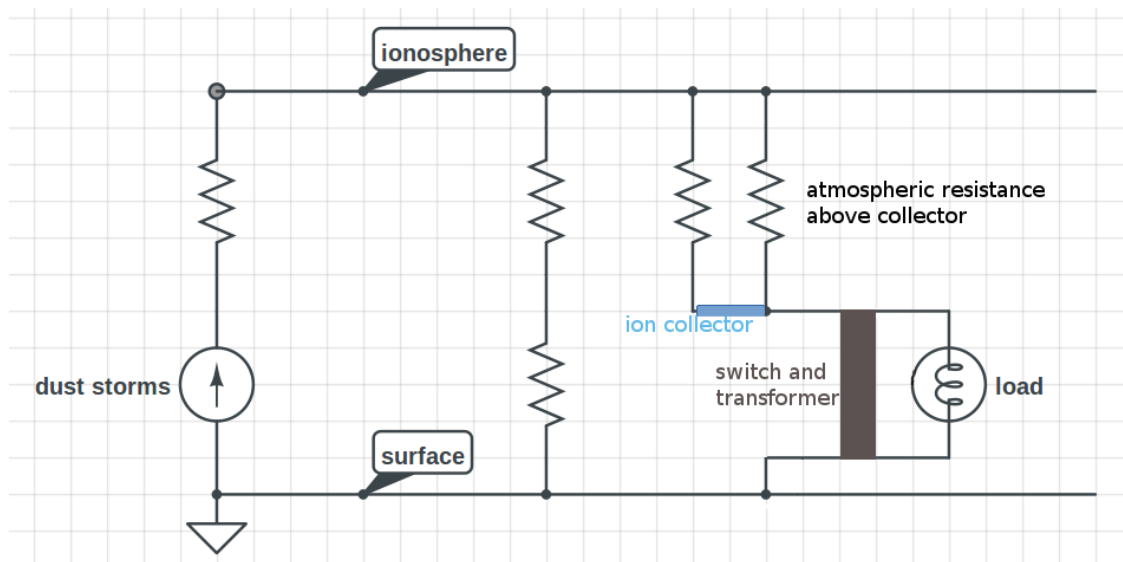

Illustration 5: Power generation from Martian GEC in a circuit representation.

## 2.2 Solar Power

For solar power on Mars, photovoltaic (PV) as well as concentrated solar thermal power generation are likely to be feasible on Mars. Modern PV systems have an efficiency of up to 25%. This means, that from incoming solar radiation 25% can be converted to electrical power. The incoming solar radiation on Mars is smaller than on Earth. This is generally expressed as the solar constant, which amounts to  $1367 \text{ W/m}^2$  on Earth, and to  $589 \text{ W/m}^2$  on Mars. Assuming optimal conditions, approximately 150 W could be generated with 1 square meter of PV cells. Depending on atmospheric loss, solar angle, and other factors an average efficiency of less than  $100 \text{ W/m}^2$  is more likely, however. For example, if a PV array is positioned at  $25^\circ \text{ N}$  on Mars, and the array measures  $100\text{m} \times 100\text{m}$  ( $10.000 \text{ m}^2$ ), 100 kW can be generated.

A second technology to harvest solar power is to employ “Concentrated solar power” (also called “concentrated solar thermal”). This method uses the heat of the sun's radiation to generate electricity. However, this requires conventional steam driven turbines and therefore would require a large amount of material transport from Earth to Mars. At the current time this does not appear to be a sensible choice and will not be considered further in this report.

## 2.3 Nuclear Power

Nuclear power, more exactly known as fission power, has been considered as an alternative power source for Mars, based on a system that was originally designed for application on the Earth's Moon. Poston (2011) give details for the design and characteristics of such a system. The technology is referred to as NASA's Reference Fission Surface Power (FSP) System and is a 40 kW system that has been primarily designed for lunar applications. The paper concludes that the environmental differences between potential mission locations will not require significant changes in design and technologies, unless

performance requirements for a specific mission are substantially different than those adopted for the FSP.

## 3 Options for power to Mars

### 3.1 Simulations for different locations and conditions

#### 3.1.1 Case 1: An ion collector at 10m altitude on the plains

With a potential gradient of  $500\text{V/m}$  the potential at 10 m altitude will be approximately 5 kV. Model simulations yield a current density of  $3\text{-}3.5 \text{ nA/m}^2$ . The resulting power that could possibly be harvested is therefore approximately  $1.5 \times 10^5 \text{ W/m}^2$ . This will not be enough for any real applications. This would require an array of the size  $250\text{m} \times 250\text{m}$  for 1 W and is therefore not a sensible option.

#### 3.1.2 Case 2: balloon at 500m altitude

NASA, as well as Ion Power Group, has been developing concepts for using balloons on Mars<sup>1</sup>. A balloon would be able to host ion collectors during fair-weather conditions. Because of the large potential gradient, at 500 m altitude a potential of approximately 225,000 V is present on Mars according to current knowledge. The numerical GEC model for Mars yields a power of 100 W. This is also larger based on the effective area of approximately  $250 \times 250 \text{ m}$  that a small ion-collector would be able to electrically connect to.

#### 3.1.3 Case 3: Large ring structure on mountain/volcano

Volcanic eruptions on Mars are extremely unlikely, the last eruption might have been around 1 Million years ago. There might still be molten magma bodies beneath the Tharsis volcanoes, and

1 <http://mars.jpl.nasa.gov/technology/balloons/> accessed on October 20, 2015

beneath Elysium Mons, but none of them would be considered a threat to human settlements.

Numerical model simulations show a much enhanced current density on mountains because of the lower resistance of the air. For example, on Olympus Mons current densities of up to 300 nA/m<sup>2</sup> can be expected. With a potential of 2000 kV a power density of up to 0.5 W/m<sup>2</sup> could be expected.

### 3.1.4 Case 2: Storm conditions

Compared to fair-weather, within dust storms much larger electric fields and current flow occur. Therefore, using storms for ion power generation is likely to be much more efficient. No balloons would be required, since large vertical electric fields are likely to be present close to the surface. The ion power technology itself is very durable and can be operated in the harsh storm conditions. Options for a power generation concept are discussed in a chapter below.

Here we present upper-limit estimates of the power that can be harvested based mainly on the data and assumptions published in peer-reviewed literature, most importantly by Farrell and Desch (2001) as well as Melnik and Parrot (1998).

Table 2 shows the used data published by Farrell and Desch (2001). The electric fields are based on the assumption of a vertical electric field of 1kV/m inside a dust storm.

We also use the low-altitude electrostatic potentials in a dust storm calculated by Melnik and Parrot (1998). Illustration 1 on page 6 shows their electrostatic potential of a simulated dust storm at different times of the simulation. Potentials of up to 160 kV with respect to the ground are shown within an altitude of 100 m. Also evident is a high variability in space and time.

For a lower limit estimate, we assume a 50 kV potential for the derivations of power that can be

harvested with ion power.

We assume a small ion harvesting unit with a collector extent on the order of 10m. Based on simulations with the Mars GEC model used here, an effective area of ion harvesting of 20x20 m is likely. For an upper limit, a 200 kV potential is assumed, as well as an effective area of 200x200 m.

	Regional	Moderate	Small
Total Power of storm	3660 GW	7.3 GW	12 MW
Estimate for power that can be harvested with a ion collector unit (lower limit)	15 W	4 W	1 W
Estimate for power that can be harvested with a ion collector unit (upper limit)	5900 W	1600 W	380 W

Table 2: Power estimates for different storm types

Compared to fair-weather power of  $1.5 \times 10^{-5}$  W/m<sup>2</sup> derived above, the electric power present in a storm is greater by a factor of between 150 to 10,000. Therefore, this is likely to be the most efficient method on Mars for the usage of ion power technology. Due to the very harsh conditions, balloons would unlikely be a feasible technology.

No benefits can be gained from ion power generation in storms at higher elevations. In the lower atmosphere, the potential contours are likely to follow the terrain altitude due to the local current generation. The air conductivity is less relevant for this process.

Ion power experiments that compared fair weather and storm conditions on Earth confirm the large increase in power density by several orders of magnitude.

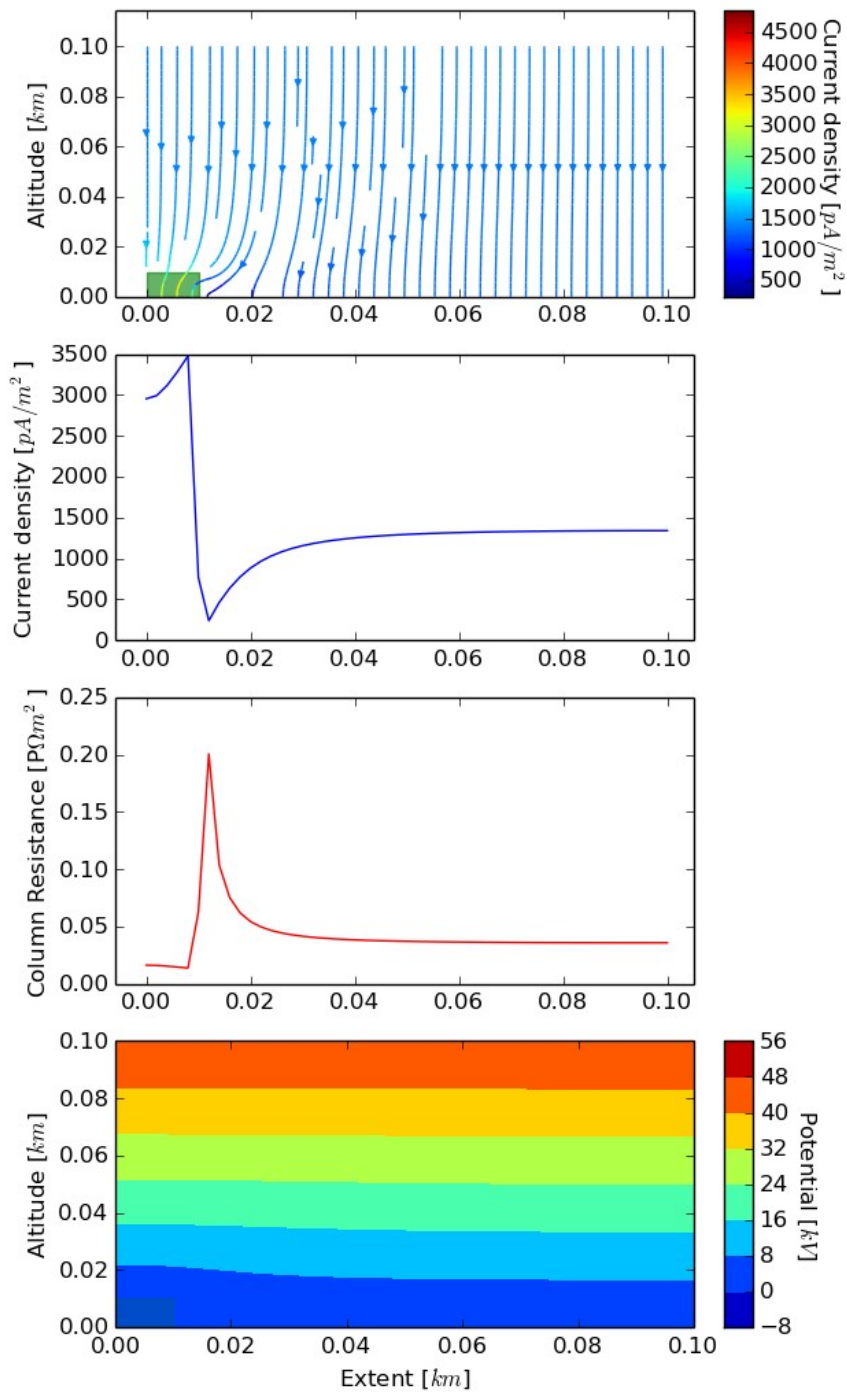

Illustration 6: Model simulation results for current densities, resistance and potential. An ion collector is located at 0 at a height of 10m and with a length of 10m.



Illustration 7: Complex caldera of Olympus Mons on Mars. Photo taken by the High Resolution Stereo Camera (HRSC) on board ESA's Mars Express spacecraft. Image Credit: ESA

	Regional	Moderate	Small	Devil
Area (km × km)	500 × 500	50 × 50	5 × 5	0.05 × 0.05
Height, km	20	15	10	1
$R_H$	109 $\Omega$	30.7 k $\Omega$	8.7 M $\Omega$	560 G $\Omega$
$V^a$	20 MV	15 MV	10 MV	1 MV
$I, ^b$ A	183,000	487	1.2	$2 \times 10^{-6}$
$J_z, ^c$ A/m <sup>2</sup>	$1.3 \times 10^{-9}$	$3.4 \times 10^{-12}$	$8.0 \times 10^{-15}$	$1.2 \times 10^{-20}$
$E_z, ^d$ V/m	451	1.2	$2.8 \times 10^{-3}$	$4.4 \times 10^{-9}$
Storm season	1	20	100	200
Nonstorm season	—	—	50	10,000

<sup>a</sup>Voltage in dust cloud  $V$  is assumed 1 kV/m internal electric field multiplied by the cloud height.

<sup>b</sup>Current from storm with  $R_H > R_{A,L,G}$ :  $I \sim V/R_H$ .

<sup>c</sup>Fairweather current density,  $J_z = I/A_{\text{fair}}$ , where  $A_{\text{fair}}$  is the area in clear-weather regions.

<sup>d</sup>Ground-level fairweather electric field,  $E_z = \rho_0 J_z$ , where  $\rho_0$  is the ground-level resistivity.

Table 3: Martian dust storms as current generators. From Farrell and Desch (2001).

### 3.2 Comprehensive power generation concept

As an example, the following concept is based on the power consumption estimates from Antarctic research stations. Similar to proposed stations on Mars, for Antarctic stations electricity is required for light, pumps, and scientific experiments. Based on Neumayer-Station III data, which can host up to 40 people, this amount to 70 kW – 300 kW. For heating, i.e. thermal energy,

another 70 – 150 kW are required for Antarctica. For Mars, an even better building insulation concept is required, reducing the required thermal energy further.

For the buildup of such a station the following concept is proposed.

Location: 25° N at base of volcano (see Illustration 8 for a map with possible locations), if possible near places where materials for supporting pole structures or even for wiring (any

material with high electrical conductivity) can be mined or extracted. Unmanned Mars missions before a settlement need to establish not only further understanding of the GEC on Mars, but also of possibilities and techniques to mine or otherwise obtain materials for supporting structures for the base and the power generation technologies.

Landing time frame: beginning of northern hemisphere summer on Mars.

### 3.2.1 Phase 1: small station buildup

- 20 balloons for 2 kW
- 10 x 10m solar panels for 10 kW

An initial power supply for summer and fall with up to 12 kW. When the dust season has started, power supply (including some likely variability) is shown in Illustration 9.

### 3.2.2 Phase 2

After the initial settlement, in a phase 2, for

example in the next summer, mining and generation of a larger power supply structure could be initiated.

A ring structure on the volcano or mountain can be setup. With up to  $0.5 \text{ W/m}^2$  (depending on installed altitude) and virtually any length, the required power can be generated. For example, for 70 kW as a base supply for a station similar to the Neumayer III station, a length of 140 km would need to be installed on Olympus Mons. Lower volcanoes / altitudes for installation would generally require larger structures.

For spring and summer, solar power production maximizes during the day. In fall, some solar power and some ion power could contribute to the power supply. In winter, mostly ion power (available for 24h) would supply energy for heating as well as regular electrical power, with only some small amount of solar power that is available.

Scientific experiment schedules could be adjusted to this time frame as much as possible.

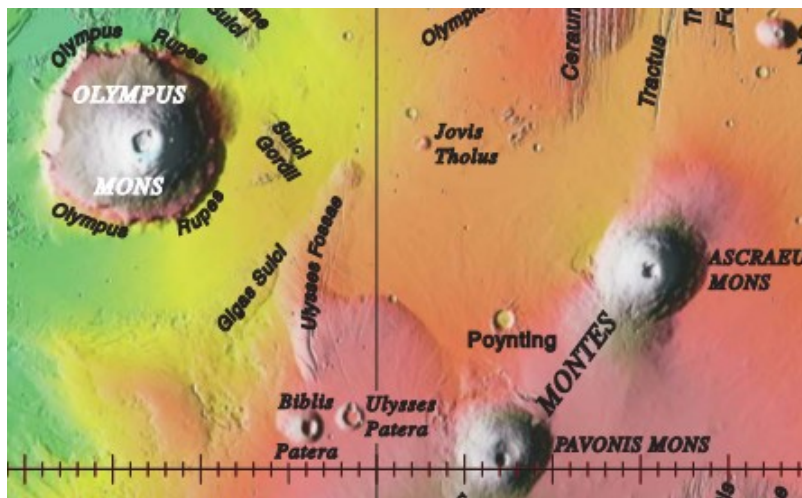
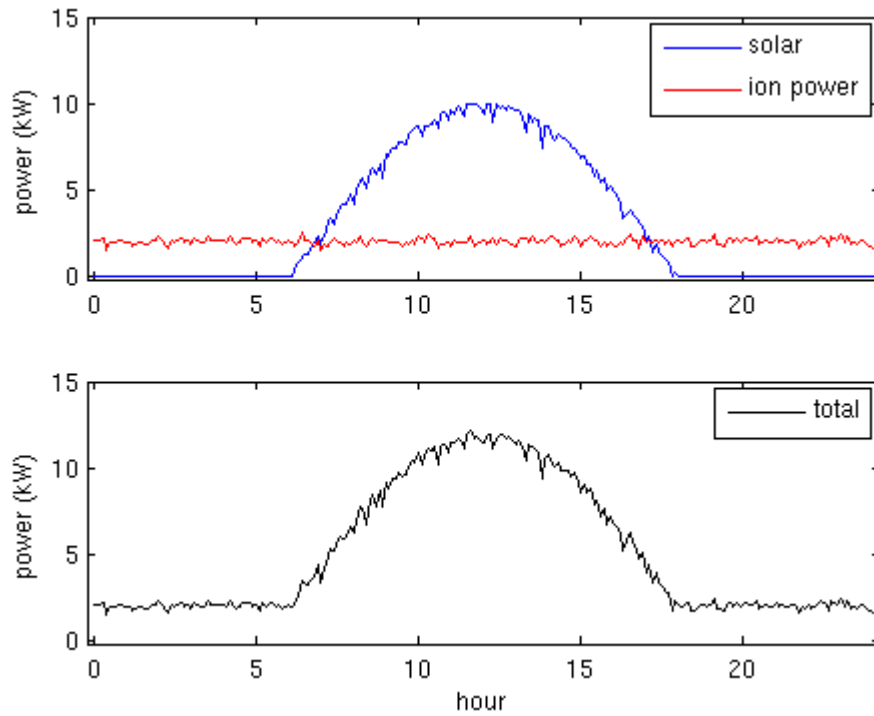
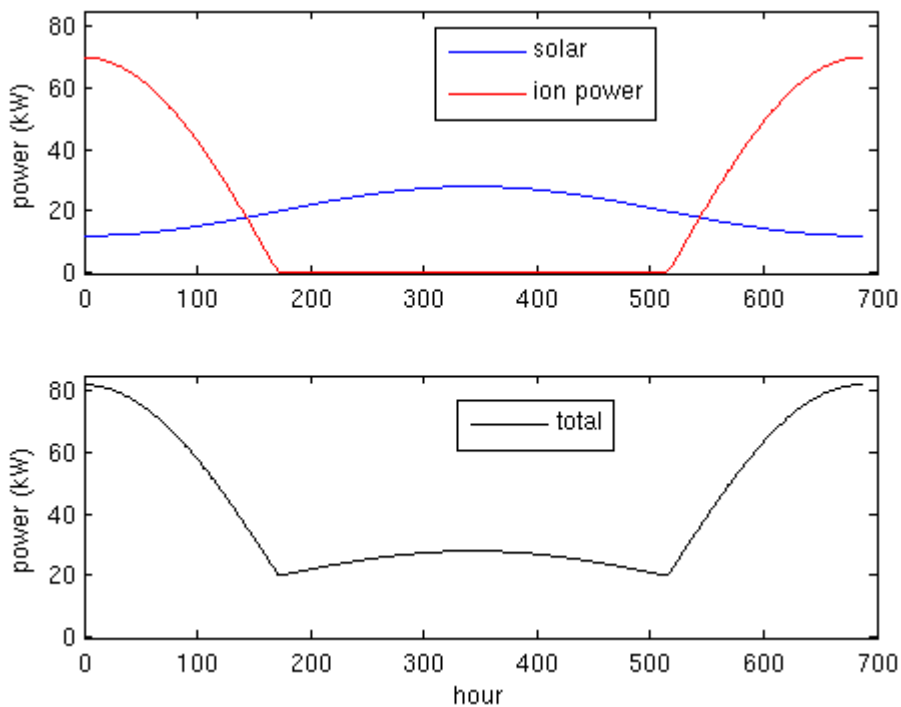

Illustration 8: Topographic map for north of the equator (approx. 2S-28N, 130W-100W). Image credit: USGS



*Illustration 9: Power generated from 20 ion power balloons and a 10x10m solar panel array (with simulated noise).*



*Illustration 10: Possible combination of solar and ion power for a year on Mars. Assumptions: 28 kW solar, up to 70 kW ion power.*

### Unmanned field sites

For an unmanned field site, ion harvesting using balloons in combination with solar cells would be an ideal combination of power sources.

### Sites in the dust storm region

If regions with a very high frequency of dust storm occurrence can be identified, a manned or unmanned station for ion power generation that is setup for storm condition ion harvesting might be considered. In the chapter above, it was shown that under the discussed assumptions an output of more than 5 kW is possible. However, further simulations and measurements on Mars will be needed to confirm this. The durable ion collector technology can be operated during the storm, with collectors positioned on poles close to the ground. Balloons would need to be stored in a safe place. In fair-weather conditions, the balloons would be released again to generate power from the GEC.

For a manned station, a location in a region with less dust storms would be preferable. An additional unmanned storm-site location could be used for food generation or as a computing center. Both of these have high electricity demand.

### Autonomous rovers for tracking dust storms

An alternative option is to follow dust storms with an ion power technology power plant. For this concept, rovers or other suitable vehicles can be equipped with small and mobile ion power technology as well as high-capacity batteries for charging. The vehicle would follow dust storms and continuously generate power that charge batteries. Once charged, the batteries can be returned to the station as an electricity supply for the station, and the autonomous vehicle would pick up empty batteries for a new mission. Using several autonomous vehicles a continuous power supply might be realized with this concept.

The spacecraft that is used to reach Mars is required to carry batteries for life support during the travel. These batteries can be re-used on the vehicles for this concept.

Following the most active region of a moderate storm, a power of 100 W appears possible from

the above discussion (Table 3). For example, for a 100 kWh battery set, about 2 days would be required for charging.

## 4 Summary

Unmanned Missions will need to prove the existence of a GEC by making measurements of electric fields, current density, and conductivity in the fair weather atmosphere and inside dust storms. These measurements also need to return important data on the atmospheric and surface composition. If the assumptions used here are confirmed, the GEC as a fair-weather current source as well as the currents inside of Martian dust storms could potentially provide a power source for missions to the surface.

Fair-weather power generation using balloons or high altitude sites has been shown to be able to provide a significant amount of electricity during the dust storms season of a Martian year. Ion power generation inside or in the vicinity of a dust storms has been shown to yield even higher current densities than in fair-weather. **Ion harvesting is thus a strong technology option for power generation.**

Solar power will also be part of a power generation concept, but cannot be used at night and during dust storms. However, it will be required for times of the year with no or only small storm activity.

**It has been shown here that ion power and solar power can be combined to provide a reliable and safe power generation concept.**

## 5 Appendix

### 5.1 GEC Model details and assumptions

Atmospheric electrical conductivity (the inverse of resistivity) largely determines the fair-weather current distribution and global resistance. Conductivity,  $\sigma$ , is proportional to the product of



ion mobilities,  $\mu^+$ ,  $\mu^-$ , and ion concentration,  $n$ :

$$\sigma = ne(\mu^+ + \mu^-)$$

where  $e$  is the elementary charge. Ion concentration for positive and negative ions is assumed to be equal, and is determined by the equilibrium of ion production and loss rate. Cosmic rays are the main ionization source in the Martian atmosphere to the current knowledge. Ion-ion recombination and ion attachment to cloud droplets and sand dust lead to a loss of ions for conductivity.

From conductivity, column resistance and global resistance can be derived, which are both important parameters for the GEC. Column resistance is defined as the vertical integration of the reciprocal of conductivity:

$$R_{\text{col}} = \int_{\text{surface}}^{\text{ionosphere}} \frac{1}{\sigma(z)} dz$$

where  $dz$  are the layer thicknesses. Then, global resistance can be calculated as the horizontal integral of reciprocal column resistance:

$$R_{\text{tot}}^{\text{col}} = \left( \iint \frac{r^2 \cos(\lambda) d\phi d\lambda}{R_{\text{col}}(\phi, \lambda)} \right)^{-1}$$

where  $r$  is the Earth's radius,  $\phi$  is longitude and  $\lambda$  is latitude. For Mars, this yields approximately 10 Ohms.

The defining equations for current flow are the current continuity equation and Ohm's law:

$$\nabla \cdot J = S$$

$$J = \sigma E,$$

where  $J$  is the current density,  $S$  is the negative time derivative of charge density, which describes the dust storms,  $\sigma$  is conductivity, and  $E$  is the electric field.

If no changing magnetic fields are present, the electric field is defined as the gradient of a potential  $\Phi$ :  $E = -\nabla\Phi$ , in which case Ohm's law can be written as  $J = -\sigma\nabla\Phi$ .

Combining Ohm's law and the current continuity equation yields the partial differential equation

$$(\text{PDE}) - \nabla \cdot [\sigma\nabla\Phi] = S.$$

To solve this for the current density and potential distributions, we employ a finite element model formulation, which requires a variational formulation of the PDE. Incorporating boundary conditions, the problem can be written as:

$$-\nabla \cdot [\sigma\nabla\Phi] = S \quad \text{in } \Omega,$$

$$\Phi = \Phi_E \quad \text{on } \Gamma_E,$$

$$\sigma\nabla\Phi \cdot n = 0 \quad \text{on } \Gamma_L \text{ and } \Gamma_R,$$

where  $\Omega$  represents the domain that the PDE is solved for (i.e. a region of the atmosphere),  $\Gamma_E$  is the earth boundary, and a Dirichlet boundary condition is implemented with  $\Phi_E$  the fixed potential of the earth, here arbitrarily taken to be zero.  $\Gamma_R$  and  $\Gamma_L$  represent the left and right boundaries of the domain. For the top boundary to the ionosphere, a Neumann boundary condition can be chosen  $\nabla\Phi \cdot n = 0$ .

Alternatively, it is possible to use a Dirichlet boundary condition (i.e., enforce a fixed value at the top).

The variational form of the PDE solves for  $\Phi \in V$ , where  $V$  is a suitable function space, such that  $a(\Phi, v) = L(v) \forall v \in V$ , and

$$a(\Phi, v) = \int_{\Omega \setminus \Omega_C} \sigma\nabla\Phi \cdot \nabla v dx + \int_{\Omega_C} \sigma_c \nabla\Phi \cdot \nabla v dx$$

$$L(v) = \int_{\Omega} S v dx$$

where integrals over the  $\Gamma_L$  and  $\Gamma_R$  boundaries would appear in  $L(v)$  if they were non-zero.

This formulation was implemented in the Fenics Python program (Logg et al., 2012) to obtain the potential and current distribution throughout the domain. Further details can be found in e.g. Baumgaertner (2014).

For Mars, after Farrell and Desch (2001), a potential of  $2.3 \times 10^6$  V is derived, using an average conductivity profile of

$\sigma = 2.8 \cdot 10^{-12} \cdot \exp(z/4.8 \text{ km})$  where  $z$  is altitude in km.

Note that all results are derived from theory only, and can only be used as a guidance to be evaluated by experiments and measurements.

## 5.2 Abbreviations and units

### Acronym

GEC	Global Electric Circuit
DC	Direct current (opposed to AC, alternating current)
PV	photo-voltaic
UV	Ultraviolet radiation

Symbol		unit
P	Power	W (Watt)
$\sigma$	Electrical conductivity	S (Siemens)
U	Voltage / potential	V (Volts)
	Atmospheric pressure	mb (millibars)

## 5.3 References

- Aplin, K. (2006): Atmospheric Electrification in the Solar System, Springer, <http://link.springer.com/article/10.1007%2Fs10712-005-0642-9>
- Baumgaertner, A. J. G., Lucas, G. M., Thayer, J. P., and Mallios, S. A. (2014): On the role of clouds in the fair weather part of the global electric circuit, Atmos. Chem. Phys., 14, 8599-8610, doi:10.5194/acp-14-8599-2014
- Crowley, J. M. (2011): The Fair-Weather Atmosphere as a Power Source, Proc. ESA Annual Meeting on Electrostatics 2011, Paper A2, <http://www.electrostatics.org/images/a2.pdf>
- Haider, S. A., Mahajan, K. K., Kallio, E. (2011): Mars ionosphere: A review of experimental results and modeling studies, AGU, 2011. <http://adsabs.harvard.edu/abs/2011RvGeo..49.4001H>
- Evtushenko, A. A., N. V. Ilin, F. A. Kuterin (2015): On the existence of a global electric circuit in the atmosphere of Mars, Physics of Earth, Atmosphere, and Hydrosphere, Springer. <http://link.springer.com/article/10.3103%2FS0027134915010063>
- Mach, D. M., R. J. Blakeslee, M. G. Bateman, and J. C. Bailey (2009), Electric fields, conductivity, and estimated currents from aircraft overflights of electrified clouds, J. Geophys. Res., 114, D10204, doi:10.1029/2008JD011495.
- Melnik, O., Parrot, M. (1998), Electrostatic discharge in Martian dust storms, J. Geophys. Res., 103, NO. A12, p. 29,107-29117
- Logg et al., 2012: The FEniCS book: Automated Solution of Differential Equations by the Finite Element Method, Lecture Notes in Computational Science and Engineering, Volume 84, doi:10.1007/978-3-642-23099-8
- Farrell, W. and Desch, M.: Is there a Martian atmospheric electric circuit? J. Geophys. Res., 2001 doi:10.1029/2000JE001271
- Delory, G. T. et al: (2001): A Global electric Circuit on Mars. <http://www.lpi.usra.edu/meetings/lpsc2001/pdf/2150.pdf>
- Gierasch, P. J., Martian dust storms, Rev. Geophys., 12, 730, 1974
- Greeley, R. et al. 1977: Dust storms on Mars: Considerations and Simulations, NASA Technical Memorandum 784323
- Logg, A., Mardal, K.-A., and Wells, G. N., (Eds.): Automated Solution of Differential Equations by the Finite Element Method, Springer Berlin Heidelberg, doi:10.1007/978-3-642-23099-8, 2012.
- Poston, D. I., 2011, Extensibility of the fission surface power (FSP) system from the moon to Mars. Report Numbers: LA-UR-11-740, TRN: US1204524 <http://www.osti.gov/scitech/biblio/1050019/>
- Ruf, C., N. O. Renno, J. F. Kok, E. Bandelier, M. J. Sandler, S. Gross, L. Skjerve, and B. Cantor, "Emission of non-thermal microwave radiation by a Martian dust storm," Geophys. Rev. Lett. **36**, L13202 (2009). [CrossRefADS](https://doi.org/10.1029/2009GL012782)
- USGS, Topographic map of Mars [http://pubs.usgs.gov/imap/i2782/i2782\\_sh1.pdf](http://pubs.usgs.gov/imap/i2782/i2782_sh1.pdf)